

# INSTRUCTION MANUAL

和文取説は、裏面にあります

## Spray Gun

### WIDER1

### Important

This manual contains **IMPORTANT WARNINGS** and **INSTRUCTIONS**. Equipment in this manual is exclusively for painting purposes. Do not use for other purposes. The operator shall be fully conversant with the requirements stated in this instruction manual including important warnings, cautions and operation and correct handling. Read and understand the instruction manual, before use and retain for reference.

Be sure to observe warnings and cautions in this instruction manual. If not, it can cause paint ejection and serious bodily injury by drawing organic solvent. Be sure to observe following  marked items which are especially important.	
<b>WARNING</b>	Indicates a potentially hazardous situation which, if not avoided, may result in serious injury or loss of life.
<b>CAUTION</b>	Indicates a potentially hazardous situation which, if not avoided, may result in minor or moderate injury or property damage.
<b>Important</b>	Indicates notes which we ask you to observe. The safety precautions in this instruction manual are the minimum necessary conditions. Follow national and local regulations regarding fire prevention, electricity and safety as well as your own company regulations.

Symbol Marking on the Spray Gun:											
This ANEST IWATA spray gun complies with 2014/34/EU Directive relating to equipment and protective systems intended for use in explosive potentially atmospheres.			II	2	G	Ex h	IIB	T6	Gb	X	T <sub>Amb</sub> +5°C~+40°C
	Complies with European Directive	Specific Marking for Explosion Protective	Group II (Surface)	Category (Zone 1&2)	Type of Atmosphere (GAS)	Ignition Protection (not applied)	Explosion Group (Ethylene)	Temperature Class (≤85°C)	Explosion Protection level (EPL)	Additional conditions: Any static Electricity should be discharged and needs to be diverted to the ground via a conductive air hose not included.	Ambient Temperature

### Important specifications

Max. Pressure	0.70MPa / 7.0bar / 100psi
Noise level	78.7dB(A)
Spray condition	Recommended
Measuring point	1m backwards from spray gun, 1.6m height
Max. temperature	Atmosphere: 5°C~40°C (41°F~104°F) ; Air and Fluid: 5°C~43°C (41°F~109°F)

Fluid nozzle – Fluid needle assy combination

Fluid nozzle		Fluid needle assy
Orifice Φ mm (in)	Mark	Mark
Φ 0.8 (0.031)	/W1 /08	08H WIDER1
Φ 1.0 (0.039)	/W1 /10	
Φ 1.3 (0.051)	/W1 /13	13 WIDER1
Φ 1.5 (0.059)	/W1 /15	
Φ 1.8 (0.071)	/W1 /18	

**Important** Never connect pressure feeding paint except pressure feed type spray gun.

### Main specifications

Model	Type of feed	Nozzle orifice Φ mm (in)	Air cap assy Mark	Recommended condition		Air consumption l/min (cfm)	Pattern width mm (in)	Air & fluid connection	Mass g (lbs.)
				*1 Atomizing air pressure MPa (bar / PSI)	Fluid output ml/min				
WIDER1-08E2P	Pressure	0.8 (0.031)	E2P	0.29 (3.0 / 43)	150	270 (9.5)	190 (7.5)	Air G1/4 (NPS1/4)	290 (0.64)
-10E2P		200			220 (8.7)				
-13E2P		250			210 (8.3)				
-15E2P		250			240 (9.4)				
WIDER1-10E1S	Suction	1.0 (0.039)	E1	0.24 (2.5 / 36)	85	220 (7.8)	120 (4.7)		
-13K1S		150			155 (6.1)				
-13H2S		150			160 (6.3)				
-15K1S		175			170 (6.7)				
-15H2S		170			175 (6.9)				
-18N1S		210			170 (6.7)				
WIDER1-10E1G	Gravity	1.0 (0.039)	E1	0.24 (2.5 / 36)	95	225 (7.9)	130 (5.1)		
-13K1G		160			170 (6.7)				
-13H2G		160			175 (6.9)				
-15K1G		200			180 (7.1)				
-15H2G		190			190 (7.5)				
-18N1G		240			170 (6.0)				

\*1. Atomizing air pressure means air pressure at spray gun inlet when trigger is pulled and air flows.

## Parts list

No.	Description	Qty
1	Air cap assy	1
2	Fluid nozzle - Fluid needle assy	1
3	Needle packing set	1
4	Pattern Adj. assy	1
5	Air valve seat assy	1
6	Air valve	1
7	Air valve spring	1
8	Fluid Adj. guide assy	1

No.	Description	Qty
9	Fluid needle spring assy	1
10	Fluid Adj. knob	1
11	Air valve shaft	1
12	Air Adj. assy	1
13	Trigger assy	1
14	Trigger stud assy	1
15	Brush	1

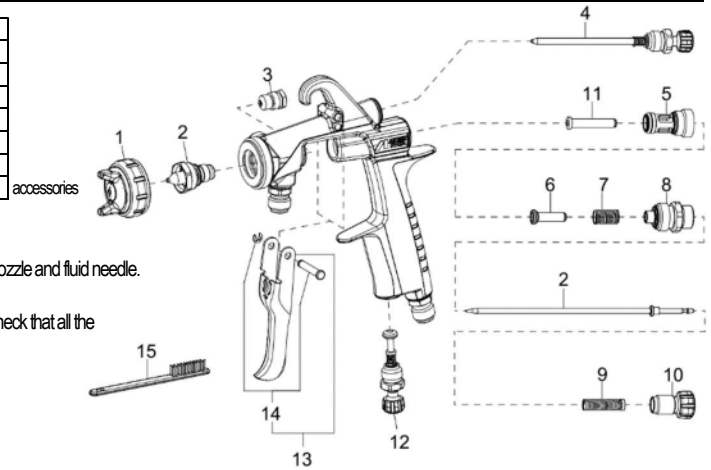

◆ Marked parts are wearable parts.

◎ When ordering parts, specify spray gun's model, part name with ref. No. and marked No. of air cap assy, fluid nozzle and fluid needle.

◎ When replacing fluid nozzle or/and fluid needle, please replace both fluid nozzle and fluid needle assy together.

◎ When receiving the spray gun, make sure that it has not been damaged during transport or storage and also check that all the above contents are inside the box.

## Safety precautions

### WARNING

#### Fire and explosion

**1. Spark and open flames are strictly prohibited.**

Paints can be highly flammable and can cause fire.

Avoid any ignition sources such as smoking, open flames, electrical goods, etc.

**2. Never use the following HALOGENATED HYDROCARBON SOLVENTS**

which can cause cracks or dissolution on spray gun body (aluminum) by chemical reaction.

unsuitable solvents : methyl chloride, dichloromethane, 1,2-dichloroethane, carbon tetrachloride, trichloroethylene, 1,1,1-trichloroethane  
(Be sure that all fluids and solvents are compatible with spray gun parts. We are ready to supply a material list used in the product)

**3. Securely ground spray gun by using air hose with built-in ground wire.**

Ground wire should have less than 1MΩ resistant. Periodically check the ground for continuity.

Insufficient grounding can cause fire or explosion due to static electric sparking.



#### Improper use of equipment

**1. Never point spray gun toward people or animal.**

If done, it can cause inflammation of eyes and skin or bodily injury.

**2. Never exceed maximum operating pressure or temperature.**

**3. Be sure to release air and fluid pressures before cleaning, disassembling or servicing.**

If not, remaining pressure can cause bodily injury or property damage.

To release pressure, first shut off the supply of compressed air and fluid to the spray gun.

Then squeeze trigger, while the spray is pointed in a safe direction.

**4. Tip of fluid needle assy and tip of fluid nozzle has a sharp point.**

Avoid touching the tip of the fluid needle or fluid nozzle during maintenance to prevent injury.



#### Protection of human body

**1. Use only in a well-ventilated area (such as in a spray booth).**

If not, poor ventilation can cause organic solvent poisoning and fire hazard.

**2. Always wear protective gear (safety glasses, mask, gloves).**

If not, paint, solvents, etc., can cause irritation of eyes and skin.

If you feel something wrong with eyes or skin, immediately see a doctor.

**3. Wear earplugs if necessary.**

Noise level can exceed 80dB(A), depending on operating conditions and painting site

**4. If operators pull the trigger many times during use, it may cause carpal tunnel syndrome.**

Be sure to take a rest if you feel tired.



#### Other precautions

**1. Never alter this spray gun.**

If done, it can cause insufficient performance and failure.

**2. Only enter the working areas of other equipment (robots, reciprocators, etc.) after machines have safely been shut down.**

If not, contact with them can cause injury.

**3. Never spray foods or chemicals through this spray gun.**

If done, it can cause accident by corrosion of fluid passages or adversely affect health by mixed foreign matter.

**4. If something goes wrong, immediately stop operation and find the cause. Do not use again until you have solved the problem.**

## How to connect

### CAUTION

- Use clean air filtered through air dryer and air filter. If not, dirty air can cause painting failure.
- Before using the spray gun for the first time, clean fluid passages with thinner to remove rust preventive oil. If not cleaned, the rust preventive oil can cause paint failure, such as fish eyes.
- Firmly connect hose or cup to spray gun. If not, disconnection of hose or drop of cup can cause bodily injury.

- Step1. Connect an air hose to air nipple tightly.
- Step2. Connect a fluid hose or a container to fluid nipple tightly.
- Step3. Flush the spray gun fluid passage with a compatible solvent.
- Step4. Pour paint into container, test spray and adjust fluid output as well as pattern width.

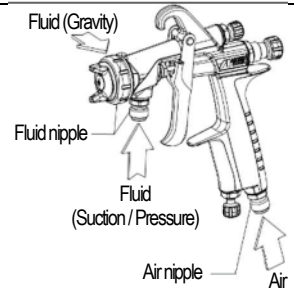

## Maintenance and inspection

### WARNING

- First release air and pressure fully according to item No. 3 of "Improper use of equipment" of WARNING on page 2.
- Only an experienced person who is fully knowledgeable of the equipment should perform maintenance and inspection.
- Use neutral cleaner: pH value shall be 6 to 8, otherwise could cause corrosion.



### CAUTION

- Only use genuine ANEST IWATA parts for any maintenance or repairs.

Step-by-step procedure	Important
<p>1. Pour remaining paint to another container. Clean fluid passages and air cap Assy. Spray a small amount of thinner into fluid passages to clean them.</p> <p>2. Clean each section with brush soaked with thinner and wipe out with waste cloth.</p>	<p>1. Incomplete cleaning can result in poor spray pattern and contaminated paint. It is especially important clean the gun fully and promptly after using two-component paint.</p> <p>2. Soaking whole spray gun in solvent may cause spray gun malfunction. Also soaking air cap Assy. itself for extended period may cause a defective spray pattern. When cleaning, never scratch the air cap Assy., fluid nozzle, or fluid needle Assy.. Avoid touching or damaging the tip of the fluid nozzle or needle.</p>
<p>3. Before disassembly, fully clean fluid passages. Remove fluid nozzle, using a ring spanner, box wrench or optional accessory spanner (code 93538601)</p> <p>4. If you need to adjust fluid needle packing set, first tighten it by hand (with fluid needle in place). Then tighten it further about 1/6 turn (60-degree) by spanner. When you remove needle packing set, do not leave the plastic tip of the packing in the spray gun body.</p> 	<p>3. During disassembly, avoid scratching the needle seating surface. Either first remove the fluid needle or hold the trigger back while removing the fluid nozzle, to protect the seating surface.</p> <p>4. If you tighten the fluid needle packing set too much, fluid needle will not move smoothly, resulting in paint leakage from tip of the fluid nozzle. Try to adjust it carefully while pulling the trigger and confirming smooth movement of the fluid needle. If you tighten it too much, first fully loosen it and then retighten again carefully..</p>
<p>5. To assemble the air valve, first assemble the air valve, air valve spring, and fluid adj. guide Assy. together. Next, insert fluid needle into fluid adj. guide Assy., then fit it to spray gun body and screw fluid adj. guide Assy. in.</p> <p>6. Before assembling the pattern adj. Assy. or air adj. Assy. back on to the gun body, fully turn the adjustment knobs counterclockwise to open. Once in the gun body the pattern adj. knob and air adj. knob can be tightened.</p>	<p>5. If you try to fit air valve spring and air valve to the spray gun body without the fluid needle, the air valve may not be fitted correctly and the packing inside fluid adj. guide Assy. can be damaged.</p> <p>6. If pattern adj. knob or air adj. knob is not fully opened when tightening into gun body, the tip of it can contact and damage the seating surface.</p>

Where to inspect	Parts replacement standard
1. Each hole passage of air cap Assy and fluid nozzle	Replace if it is crushed or deformed.
2. Packing and O ring	Replace if it is deformed or worn out.
3. Leakage from seating surface between fluid nozzle and fluid needle	Replace them if leakage does not stop after fully cleaning the fluid nozzle and needle. If you replace the fluid nozzle or fluid needle only, ensure they fully match and confirm that there is no leakage.

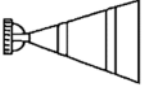
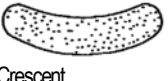
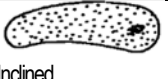
# ■ Troubleshooting

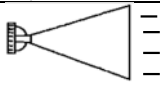
Spray Pattern	Problems	Remedies
 Fluttering	1. Air enters between fluid nozzle and tapered seat of spray gun body. 2. Air is drawn from fluid needle packing set. 3. Air enters at fluid container fitting nut or fluid hose joint.	1. Remove fluid nozzle to clean seat. If it is damaged, replace nozzle. 2. Tighten fluid needle packing. 3. Fully tighten joint section.
 Crescent	1. Paint buildup on air cap assy partially clogs horn holes. Air pressure from both horns differs.	1. Remove obstructions from horn holes with attached brush. But do not use metal objects to clean horn holes.
 Inclined	1. Paint buildup or damage on fluid nozzle circumference and air cap assy center. 2. Fluid nozzle is not properly fitted.	1. Remove obstructions. Replace if damaged. 2. Remove fluid nozzle and clean seat section.
 Split	1. Paint viscosity too low. 2. Fluid output too high.	1. Add paint to increase viscosity. 2. Turn fluid adj. knob clockwise to reduce fluid output. Or turn pattern adj. assy clockwise.
 Heavy Center	1. Paint viscosity is too high. 2. Fluid output is too low.	1. Add thinner to reduce viscosity. 2. Turn fluid adj. knob counter-clockwise to increase fluid output.
 Spit	1. Fluid nozzle and fluid needle assy are not seated properly. 2. The first-stage travel of trigger (when only air discharges) decreases. 3. Paint buildup inside air cap assy.	1. Clean or replace fluid nozzle and fluid needle assy. 2. Replace fluid nozzle and fluid needle assy. 3. Clean air cap assy.

R1: retighten R2: adjust R3: clean R4: replace parts

Problem	Where it occurred	Parts to be checked	Cause	Remedy			
				R1	R2	R3	R4
Paint leaks	Fluid nozzle	Fluid nozzle ~ Fluid needle assy	Dirt, damage, wear on seat Loose fluid needle adj. knob Wear on needle spring		○	○	○
		Fluid nozzle ~ Spray gun body	Insufficient tightening Dirt or damage on seat	○		○	○
		Needle packing set	Fluid needle assy does not return due to packing set too tight Fluid needle assy does not return due to paint buildup on fluid needle		○	○	○
	Needle packing set	Needle packing set ~ Fluid needle assy	Wear	○			○
		Needle packing set	Insufficient tightening	○			
		Needle packing set	Insufficient opening		○		
Paint does not come out	Tip of spray gun	Tip hole of fluid nozzle	Clogged			○	
		Needle packing set ~ Fluid needle assy	Clogged			○	○
		Air valve & Air valve seat assy	Insufficient tightening		○		
Air leaks (from tip of air cap assy)	Air valve & Air valve seat assy	Air valve	Dirt or damage on seat			○	○
		Air valve seat assy	Dirt or damage on seat			○	○
		Air valve seat assy	Wear on air valve spring				○

# ■ How to operate

- Suggested air pressure is 2.0 to 3.5 bar (29 to 50 PSI).
- Recommended paint viscosity differs according to paint property and painting conditions. 14 to 25 sec. / Ford cup#4 is recommendable.
- Keep fluid output as small as possible to the extent that the job will not be hindered. It will lead to better finishing with fine atomization.
- Set the spray distance from the spray gun to the work piece as near as possible within the range of 150~200 mm (5.9~7.9 in).
- The spray gun should be held so that it is perpendicular to the surface of the work piece at all times. Then, the spray gun should move in a straight and horizontal line. Arcing the spray gun causes uneven painting.

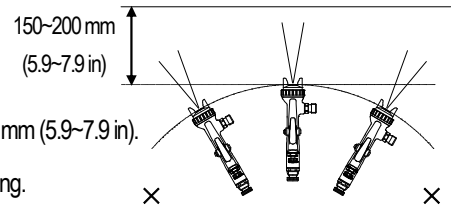

# ANEST IWATA Corporation

3176, Shinyoshida-cho, Kohoku-ku, Yokohama, 223-8501, Japan

Manual No. T924-00  
Code No. 03012690



# Residual risk

## Residual Risk Map Requiring Protective Measures by Machine Users (Abbreviated Name: Residual Risk Map)

### Product model: "Spray gun :WIDER1 / WIDER2"

2019/5/29 Create  
ANEST IWATA Corporation

※ Be sure to read and understand the instruction manual before using the product. This document is a reference material in the instruction manual and must not be used with only an understanding of the contents of this document.

Residual risk is classified and described according to the following definitions	
 <b>DANGER</b>	Contents that are likely to cause death or serious injury if protection measures are not implemented.
 <b>WARNING</b>	Contents that may cause death or serious injury if protection measures are not implemented.
 <b>CAUTION</b>	Contents that may cause minor injury if protection measures are not implemented

Symbols and numbers shown in the figure correspond to those described in the "List of Residual Risks" of the Product. Refer to the List of Residual Risks for details of each residual risk.

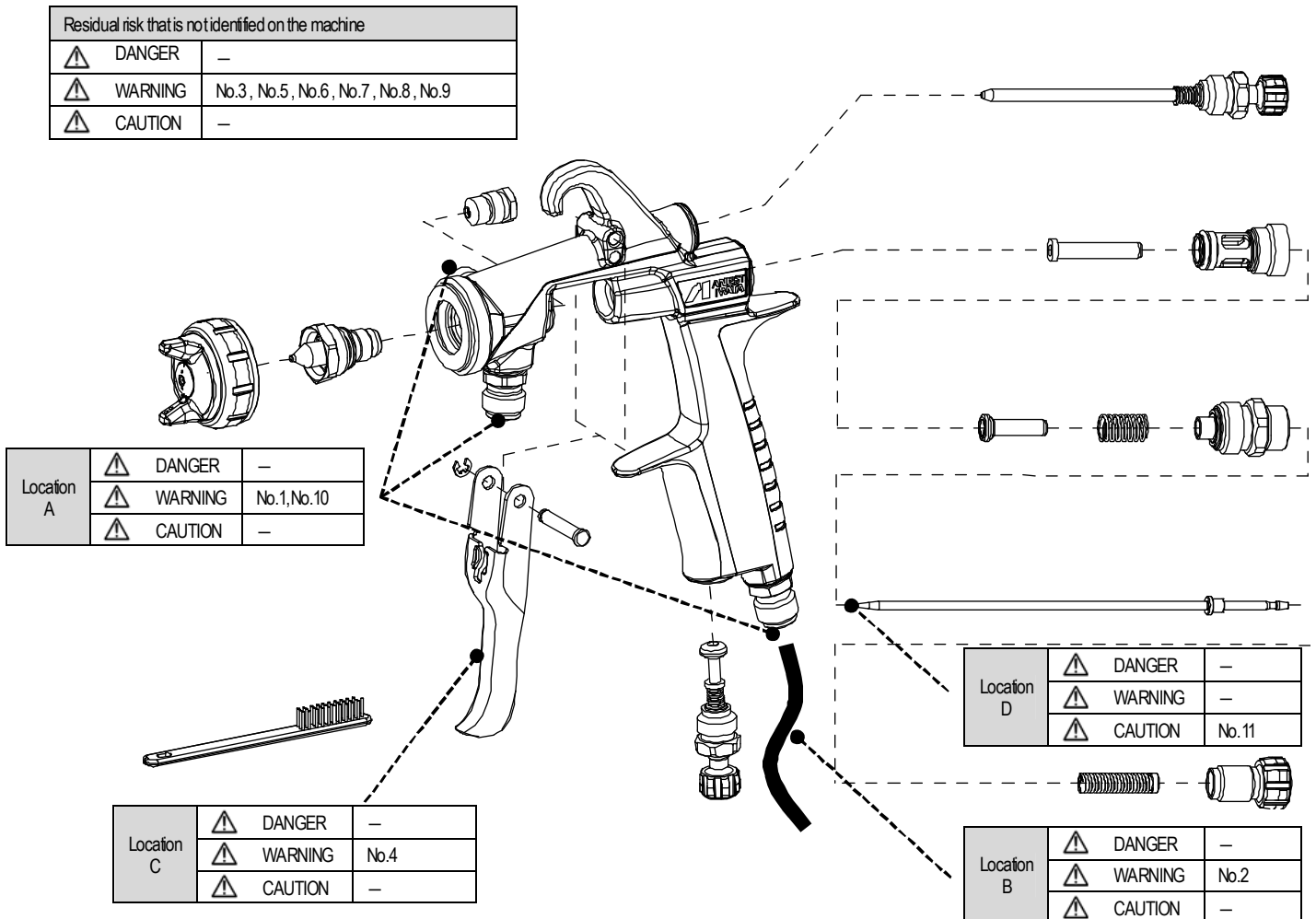



# Residual risk

## List of residual risks requiring protection measures by machine users (Abbreviated Name: List of Residual Risks)











### Product model: " Spray gun :WIDER1 / WIDER2"

2019/5/29 Create  
ANEST IWATA Corporation

※ Be sure to read and understand the instruction manual before using the product. This document is a reference material in the instruction manual and must not be used with only an understanding of the contents of this document.

※ 1 "degree of hazard" is classified and described according to the following definitions	
 <b>DANGER</b>	Contents that are likely to cause death or serious injury if protection measures are not implemented.
 <b>WARNING</b>	Contents that may cause death or serious injury if protection measures are not implemented.
 <b>CAUTION</b>	Contents that may cause minor injury if protection measures are not implemented

※2 The symbol shown as "Location on machinery" is the number of the machine section on the Residual Risk Map of the Product. See Residual Risk Map for specific points on the machinery.

No.	Operational Phase	Works	Qualifications and Training required for the work	Location on the machinery *2	Harm Degree *1	Type of Harm	Protective measure protective measure performed by the machinery user	Instruction Manual Referenced page
1	Use	Preparation work During work	—	A	 Warning	A wrong connection between the air joint and the paint joint may cause paint to spout from an unexpected place and hit the operator.	To provide personal protective equipment	P2
2	Use	All	—	B	 Warning	Ignition and fire caused by static electricity	Use of a hose with a ground and confirmation of ground	P2
3	Use and maintenance	During work, decomposition and rinse	—	Default	 Warning	Organic solvents, etc., may come into contact with the eyes and skin, causing irritation.	To provide personal protective equipment	P2
4	Use	During work	—	C	 Warning	Tenosynovitis due to repeated pulling of the trigger	Moderate rest	P2
5	Use	All	—	Default	 Warning	Fire, electrical appliances, etc. ignite, and fire generating.	Strict ban on the use of fire	P2
6	Use	Preparation work During work	—	Default	 Warning	Supply at specified pressure or higher, paint spouts from unexpected places, hitting human body or eyes, blindness	To provide personal protective equipment	P2
7	Use and maintenance	Preparation work During work	—	Default	 Warning	The product is modified, parts other than genuine parts are used, and an unexpected failure or accident generating.	No modification Use of genuine parts	P2
8	Use	Preparation work During work	—	Default	 Warning	The patient stayed in a location where noise such as blowing air was generated for a long time, resulting in hearing loss.	Use of earplugs is recommended.	P2
9	Use and maintenance	During work, decomposition and rinse	—	Default	 Warning	Organic solvent poisoning Due to inhale of solvent and paint mist	To provide personal protective equipment Work in painting booths, etc.	P2
10	Use and maintenance	Preparation work During work	—	A	 Warning	If the hoses are tried to be disconnected under pressurized condition, paint, cleaning liquid, air, etc. are spouted out and injured.	To provide personal protective equipment Remove residual pressure	P2
11	Maintenance	Preparation work	—	D	 Caution	Needle valve piercing with sharp corners	To provide personal protective equipment	P2

No.R003-00  
Code No.03014490